

EUROCASSONETTO PUNTO LUCE A DOPPIA ANTA versione intonaco

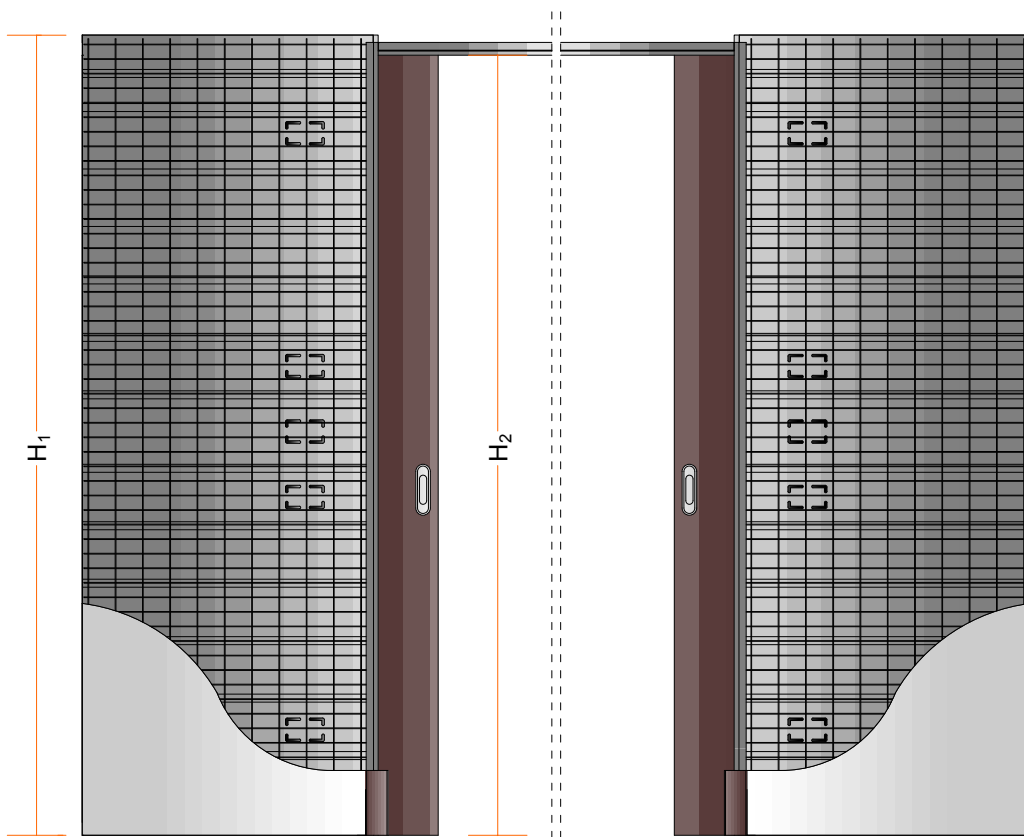

PROSPETTO

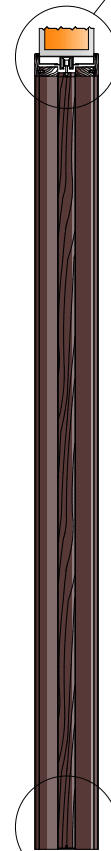
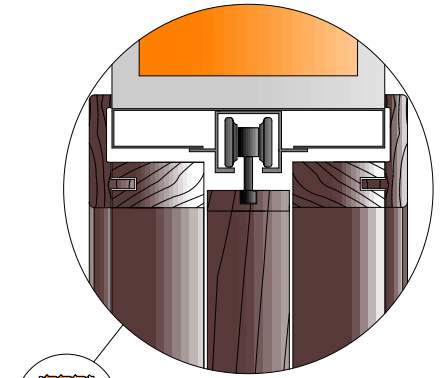

SEZIONE VERTICALE

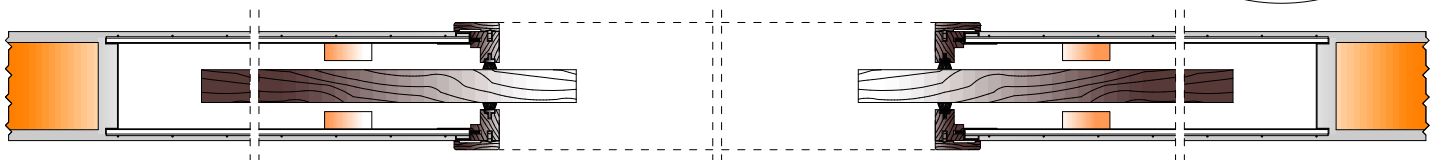
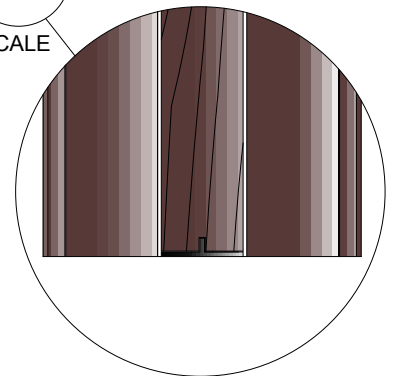

SEZIONE ORIZZONTALE

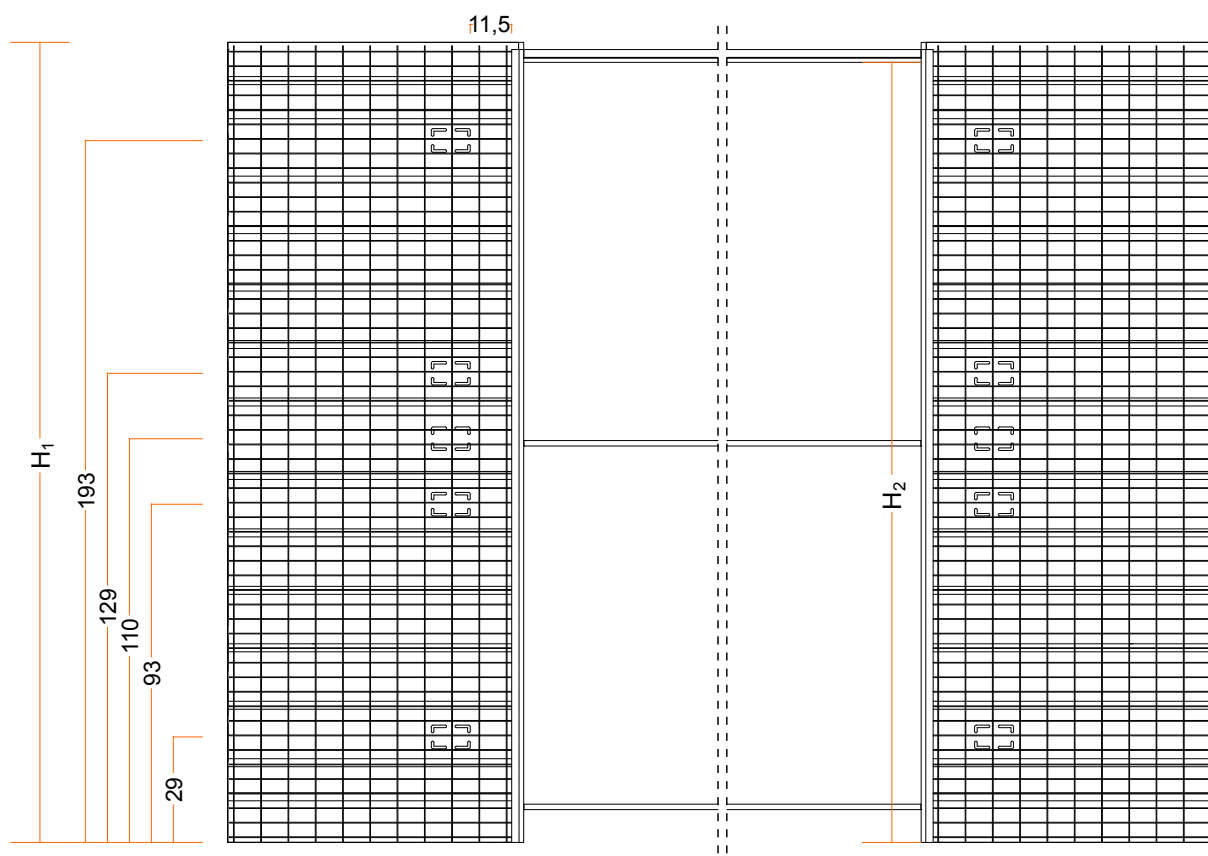

PROSPETTO

S_e	S_i
150	69

S_e = Spessore Parete Finita
 S_i = Sede interna

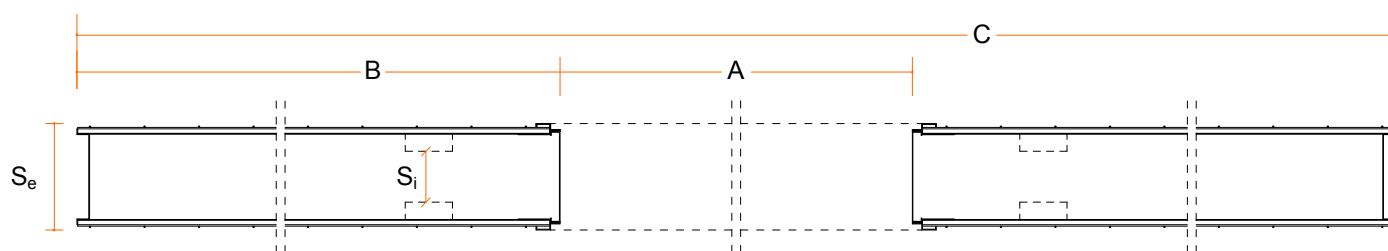

SEZIONE ORIZZONTALE

COD.	A	B	C	H_1	H_2	Misura porta LxH
E 60x210/200/202 PL D INT. (S_e)	1230	615	2460	2200/2100/2120	2145/2045/2065	N°2 610x2110/2010/2030
E 70x210/200/202 PL D INT. (S_e)	1430	715	2860	2200/2100/2120	2145/2045/2065	N°2 710x2110/2010/2030
E 80x210/200/202 PL D INT. (S_e)	1630	815	3260	2200/2100/2120	2145/2045/2065	N°2 810x2110/2010/2030
E 90x210/200/202 PL D INT. (S_e)	1830	915	3660	2200/2100/2120	2145/2045/2065	N°2 910x2110/2010/2030
E 100x210/200/202 PL D INT. (S_e)	2030	1015	4060	2200/2100/2120	2145/2045/2065	N°2 1010x2110/2010/2030
E 110x210/200/202 PL D INT. (S_e)	2230	1115	4460	2200/2100/2120	2145/2045/2065	N°2 1110x2110/2010/2030
E 120x210/200/202 PL D INT. (S_e)	2430	1215	4860	2200/2100/2120	2145/2045/2065	N°2 1210x2110/2010/2030

A = Luce Lorda ; B = Larghezza Controtelaio; C = Larghezza Complessiva; H_1 = Altezza Controtelaio; H_2 = Altezza Lorda.